



Canadian Fuels
ASSOCIATION
canadienne des carburants

Using the Canadian Fuels Colour-Symbol System To Identify Equipment and Vehicles For Product Identification

**Canadian Fuels RECOMMENDED PRACTICE
FIFTH EDITION, November 2022**

275 Slater
Suite 1000
Ottawa ON
K1P 5H9

Tel: (613) 232-3709
email: info@canadianfuels.ca

STATEMENT OF DISCLAIMER

The reader/user acknowledges that it understands that the Canadian Fuels Association (Canadian Fuels) and its members do not warrant that these are the best or only procedures, or that by reliance on these procedures, the best results can be achieved and waives any rights of action and agrees that, under no circumstances, shall Canadian Fuels, its directors and officers, or its members be liable for any claim for damages or otherwise arising from the use of or reliance on this document/publication.

The reader/user understands that existing legislation and government regulations take precedence over the procedures in this manual and that it is the sole obligation of the reader/user to determine whether the contents of the documents/publication are appropriate for their own unique circumstances and whether the reader/user wishes to rely on the contents of the document/publication.

No responsibility is accepted by Canadian Fuels or any of its members concerned with the preparation, production or publication of this report for any statements therein or omissions therefrom that may result in any loss, damage or injury whatsoever to any person relying on this document/publication.

Any manufacturer or supplier of colour-symbol equipment or materials described in this recommended practice document are solely responsible for ensuring that their manufactured or supplied colour-symbol materials conform with the applicable specifications outlined in this document. Canadian Fuels does not represent, warrant, or guarantee that such manufactured or supplied materials do in fact conform with the applicable specifications outlined in this document.

PRODUCT IDENTIFICATION AT SERVICE STATIONS, BULK PLANTS, AND DISTRIBUTION TERMINALS

SECTION 1 – GENERAL

1.1 Purpose of the System

1.1.1 This recommended practice describes a colour-symbol system (the “system”) for identifying transfer points and equipment used to store and handle bulk petroleum products.

1.1.2 A uniform and easily understood identification system facilitates petroleum industry operations. Such a system helps to prevent unintended or accidental mixing of two products.

1.1.3 The principal purpose of an identification system is to identify product transfer points for tank-truck loading and unloading to prevent errors in product handling. Personnel who handle products may make the mistake of “cross-dumping” (commingling) products if these personnel rely on memory rather than on written records.

1.1.4 Personnel who handle products should be trained and familiar with any identification system used to designate products.

1.2 Support of the System

1.2.1 The transfer point and equipment identification system described in this recommended practice facilitates easy identification of products by means of colours, tags and names. The following additional measures are recommended to support the system.

A. Providing charts to identify permanent locations of products at a facility (storage tank, loading arm, and so forth).

B. Using stencils, decals, or metal or plastic tags to identify product names on equipment.

1.2.2 The name, colour and tag shape should be the means of product identification.

Generic names are used for motor fuels, middle distillates, and aviation fuels.

Generic names include:

1.2.3 Gasoline: Super Premium, Premium, Mid Grade, Regular and Ethanol Blended Gasolines (defined as a blend of gasoline and less than 10% ethanol by volume and meeting the Canadian General Standards Board (CGSB) standard for oxygenated fuels) - including Ethanol 85 (defined as a blended gasoline containing 85% ethanol and 15% gasoline and meeting the Canadian General Standards Board (CGSB) for alcohol-based fuels).

The system does not attempt to identify all grades or octane ratings of gasoline manufactured or sold in Canada.

1.2.4 Middle Distillates: Diesel, Stove Oil, Furnace Oil, Kerosene, low sulphur diesel (defined as containing less than .0015% by weight of sulphur - 15 ppm) and biodiesel blends (a fuel component comprised of mono-alkyl esters of long-chain fatty acids derived from renewable sources and is blended with hydrocarbon diesel products to produce blends for heating fuel or motor vehicle fuels. In its neat form, biodiesel is commonly designated as B100 and typically will be used as a blendstock material to blend with hydrocarbon diesel).

1.2.5 Aviation Fuels: Avgas 100LL, Avgas 100, Jet A

1.2.6 Denatured Ethanol

The system provides for denatured ethanol as follows:

- Defined as ethanol blended with various additives to render it unfit for human consumption. The additives are called denaturants and are generally toxic or have unpleasant odours.

Generic Names will be printed on both sides of the tags in a contrasting colour to the product colour code.

1.2.7 Solvents, Lubes, Heavy Fuel Oils

The system provides a single (unique) colour to identify each group of solvents, lubes and heavy fuel oils. Due to the high number of products available, generic names are impractical. Therefore, it is important that all tags and equipment are marked with recognized nomenclature for the specific product. This could include company product name or code name. The name on the equipment and the tag should be the same as would appear on the load manifest and delivery slip for easy reference and clarity.

SECTION 2 – ELEMENTS OF THE SYSTEM

2.1 General

2.1.1 The colours used in the equipment marking colour-tag system are similar to those used in API Recommended Practice #1637 ([link](#)).

2.1.2 Tag Shapes

In this equipment identification system, the following tag shapes will identify the various classes of products:

Gasolines - Hexagonal
Mid-Distillates - Round
Aviation Fuels – Square
Denatured Ethanol - Diamond
Solvents - Triangle
Lubes - Flat sided Oval
Heavy Fuel Oil - Pentagon
(For tag specifications see Appendix III)

2.2 Colour Coding

The system provides for colour coding of tags, product transfer point piping and valves per section 3. The system does not attempt to classify all grades of fuels distributed and sold in the Canadian market. Common and generic colours and names are utilized.

The colour for products will be as follows:

Gasoline

Super Premium (above 91 AKI octane) - Bronze (Pantone 873C)
Premium (91 AKI octane) - Red (Pantone 186C)
Midgrade (89 AKI octane) - Blue (Pantone 300C)
Regular (87 AKI octane) – White (Pantone White C)

Gasoline containing ethanol – Lime Green (Pantone 361C)

Dyed Products

Products that are dyed for the purposes of identifying taxed or non-taxed status would have an orange band across the colour coding or colour tag to identify this status. The word “dyed” would be added to the generic name.

Aviation Fuels (Tags only)

(Refer to EI 1542 for piping identification)

Avgas 100LL - Blue (Pantone 300C)

Avgas 100 - Red (Pantone 186C)

Jet A - All grades - Black with grade identification in white type

Denatured Ethanol

Lime green (Pantone 361C)

Heavy Fuel Oils

Brown (Pantone 478C)

Lubricating Oils

Silver (Pantone 877C)

Solvents

Orange (Pantone 166C)

(See Appendix I for Colour Samples)

(See Appendix II for paint recommendations)

2.3 Tag Specifications

All Tags will be constructed of hydrocarbon resistant material, preferably 18 ga anodized aluminum, with a minimum material thickness of 0.5 cm. Dimensions will be as shown in Appendix III, with a 4 mm hole at the top, as shown, to facilitate a non-corrosive connector (i.e. split ring). Lettering will be a minimum of 1.25 cm in height and will be in a contrasting colour to the tag colour. Names will be on both sides of the tag. Note that for the denatured ethanol tag, lettering will be bilingual; English on one side and French

Middle Distillate

Diesel – Yellow (Pantone Yellow C)

Stove – Purple (Pantone 257C)

Furnace – Green (Pantone 336C)

Kerosene – Brown (Pantone 478C)

Low Sulphur Diesel - top half coloured yellow (Pantone Yellow C) and marked Diesel, the bottom half coloured Lime Green (Pantone 361C) and marked Low Sulphur

Biodiesel Blends – top half - yellow (Pantone Yellow C) and bottom right 1/4 circle – lime green (Pantone 361C). Bottom left 1/4 circle – brown (Pantone 478C) for biodiesel blends and purple (Pantone 257C) for 100% biodiesel.

Biodiesel blends B5 and B6 to B20 will be identified by this colour specific tag and does not specify the blend percentage.

on the other side (see French version of this document on the [CFA website](#) for French wording).

See Appendix IV for known dealer listings.

SECTION 3 – APPLICATION OF THE SYSTEM

3.1 General

3.1.1 Equipment must be identified with an appropriate colour code. Bands can be used for rounded surfaces, such as on pipelines and loading arms. A tag similar to that shown in Appendix III should be placed at strategic locations for easy identification.

3.1.2 This permanent identification system has limited application to refineries, because products and other materials flowing through piping and tankage change frequently. Companies may, however, elect to apply this equipment identification system to points of product transfer such as loading racks.

3.2 Service Stations

3.2.1 Fillboxes must be clearly identified. When the fillboxes and fillbox covers are identified by means of the system, at least one fixed component of the fillbox itself should be labeled to avoid commingling incidents that might result from mismatching fillboxes and their covers. The following labeling methods are recommended.

1. Painting or placing a decal on the top of the cover and on the rim of the fillbox.
2. Attaching a tag to the fillpipe adapter.
3. Screwing a tag onto the fillbox rim.
4. Fitting a plastic or fiberglass insert inside the rim of the fillbox.
5. A brass tag indicating capacity in litres, at or on fill pipe inlet, i.e. with product identification tag.

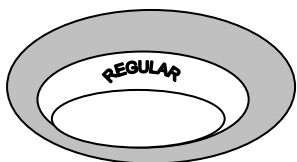

3.2.2 Product dispensers must not be included in this identification program, since individual companies prefer to use their own colours and symbols when relating to the general public.

3.3 Distribution Terminals

3.3.1 Truck, tank-car, and marine loading and unloading facilities should be identified by means of this system. The last marking should be as close as possible to the point of product transfer.

3.3.2 Storage tanks can be marked by means of this system. Labels can help prevent product commingling and afford rapid product recognition. Above ground tankage must be identified with numerals and may include product generic name, with lettering sized to be readable from a point outside the dyke area but a minimum 15 cm in height. This would back up the WHMIS program.

3.4 Vehicles

Vehicles are the most important link in the distribution system and are most susceptible to loading and unloading errors. By identifying tank outlet valves with the system tags operators can readily match the valves with similarly marked loading and unloading facilities.

3.5 Airports

The colour-symbol system described in this recommended practice does not cover airport operations. Colour-symbol systems for aviation fuels are more completely described in EI-1542 ([link](#)) and/or CSA B836 ([link](#))

3.6 Ontario Fuel Tax Act

The Ontario Ministry of Revenue amended the [Fuel Tax Act](#) to recognize the Canadian Fuels Dyed Fuel Identification Tag as fulfilling the legal requirement to identify non-taxed fuel. The tag must be bilingual with English on one side and French on the other side.

<i>Dyed Ethanol Regular</i>	–	<i>Éthanol ordinaire coloré</i>
<i>Dyed Ethanol Mid Grade</i>	–	<i>Éthanol intermédiaire coloré</i>
<i>Dyed Ethanol Premium</i>	–	<i>Éthanol super coloré</i>
<i>Dyed Diesel Low Sulphur</i>	–	<i>Diesel basse teneur de soufre coloré</i>

**APPENDIX I
COLOUR SAMPLES**

GASOLINE

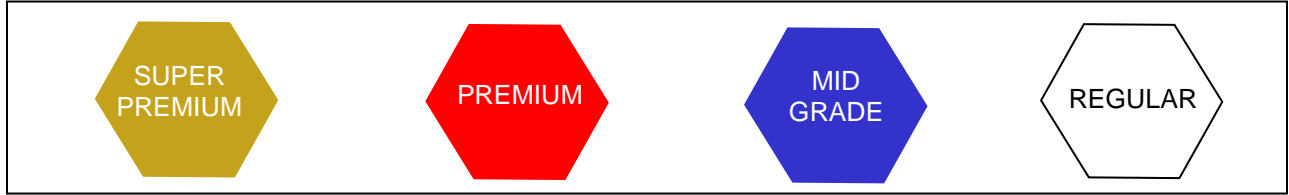

ETHANOL BLENDED GASOLINE

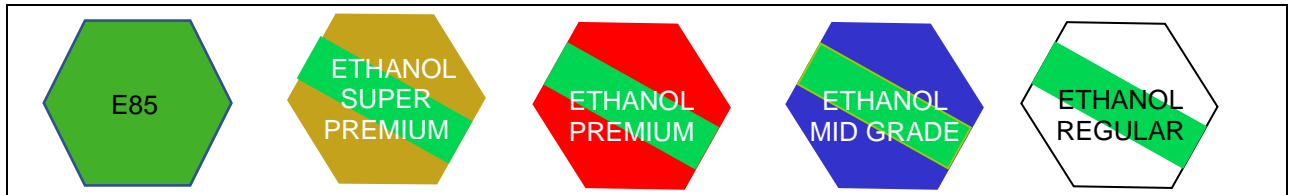

DYED GASOLINE

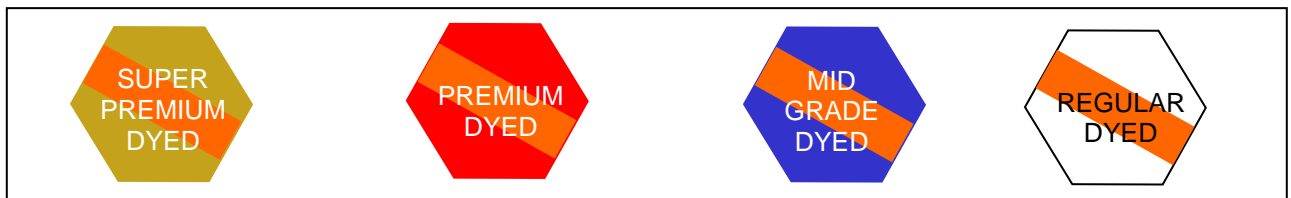

DYED ETHANOL BLENDED GASOLINE

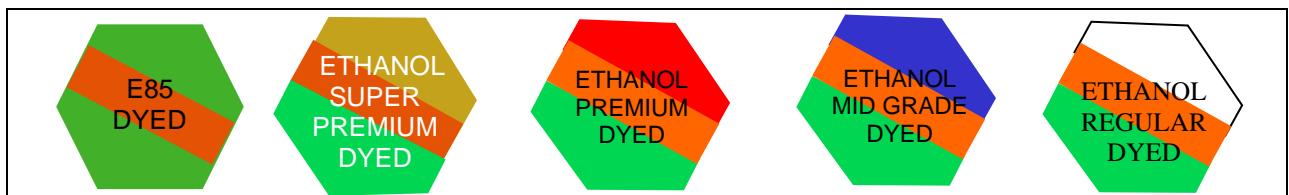

DENATURED ETHANOL

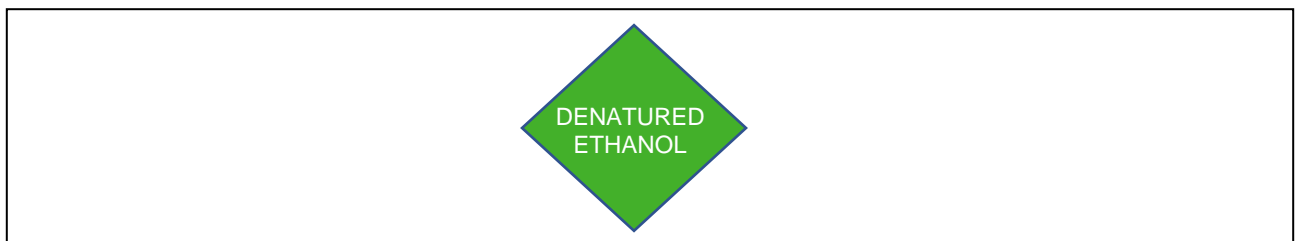

MIDDLE DISTILLATES

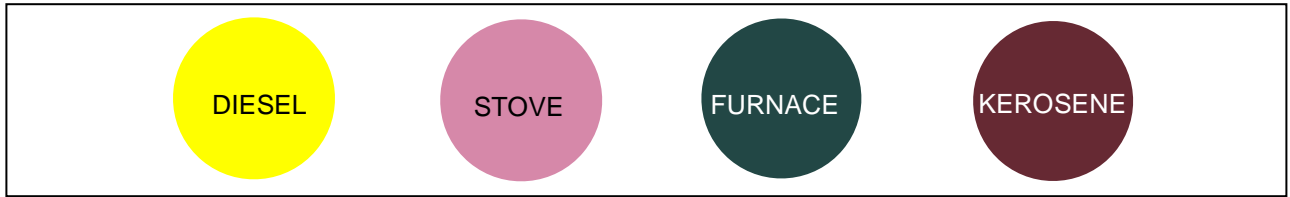

LOW SULPHUR DIESEL

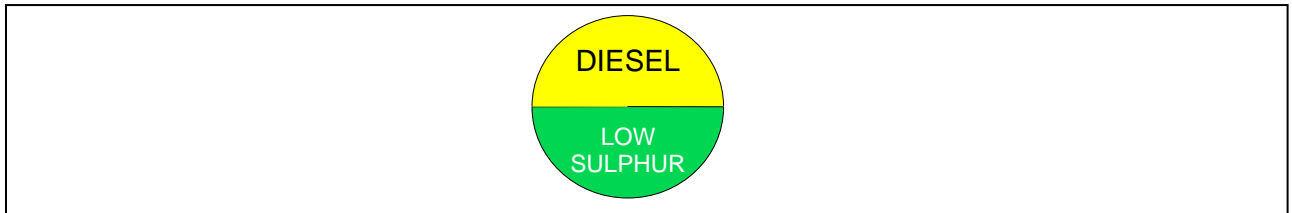

BIODIESEL BLENDS

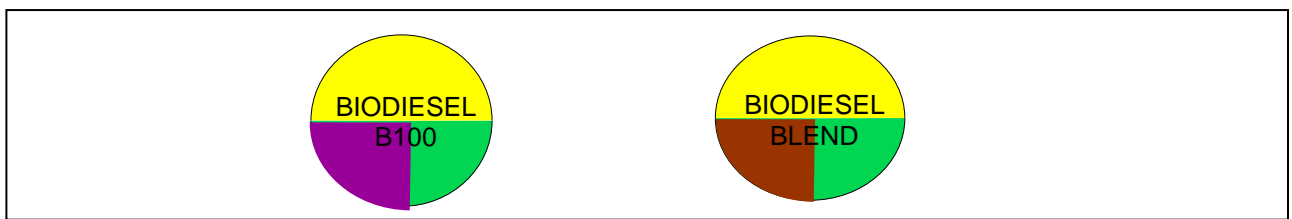

DYED MIDDLE DISTILLATES



DYED LOW SULPHUR DIESEL

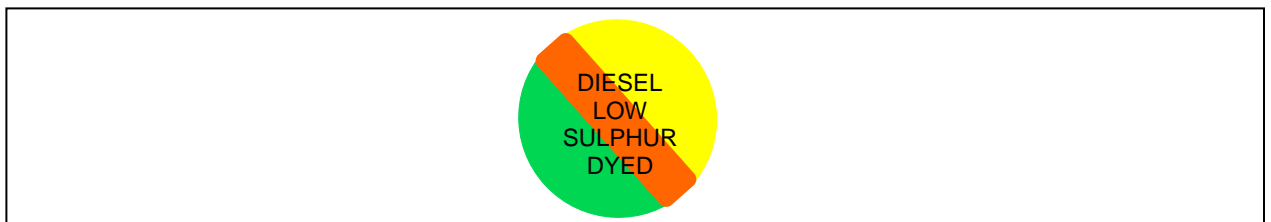

DYED BIODIESEL BLENDS

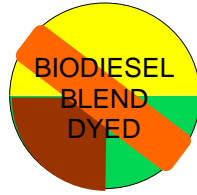

AVIATION FUELS

JET A

AVGAS
100

AVGAS
100LL

HEAVY FUEL OIL

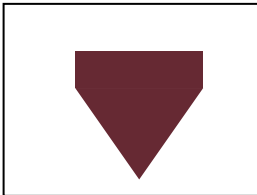

LUBRICATING OIL

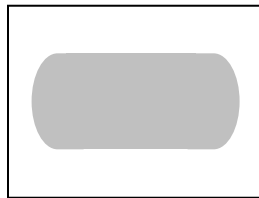

SOLVENTS

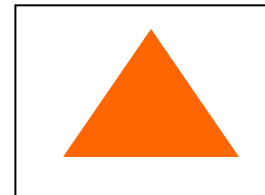

APPENDIX II
PAINT RECOMMENDATIONS

Colour Cross-Reference Chart

Colour	Pantone Number
Red	186C
Blue	300C
White	White C
Orange	166C
Yellow	Yellow C
Green	336C
Brown	478C
Black	Black C
Purple	257C
Bronze	873C
Silver	877C
Lime Green	361C

**APPENDIX III
TAG DIMENSIONS IN METRIC**

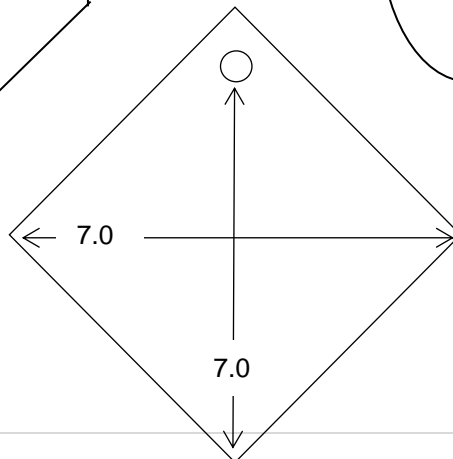
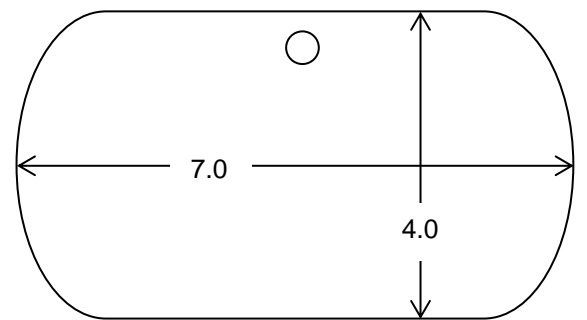
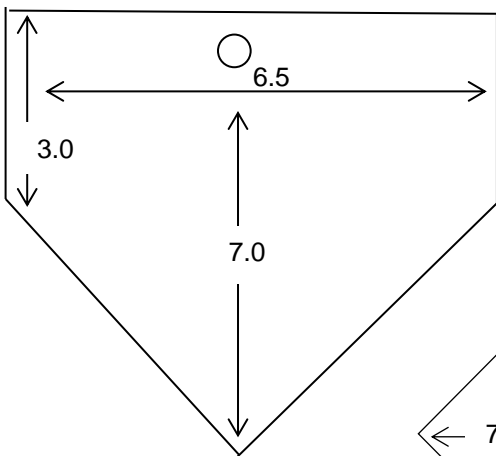
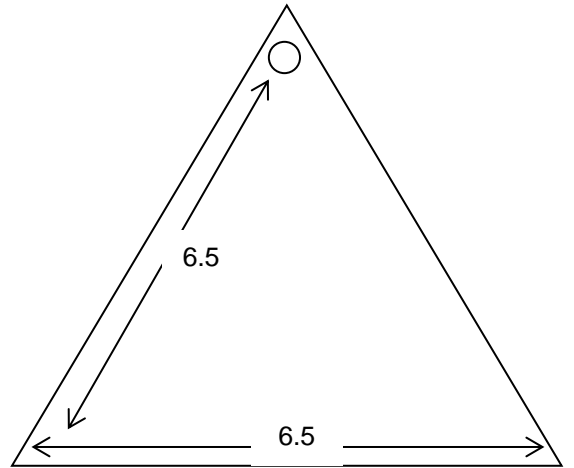
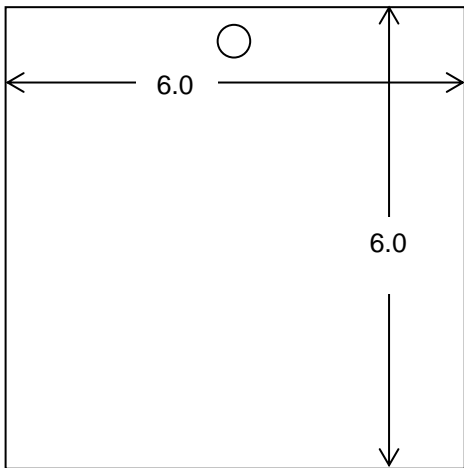
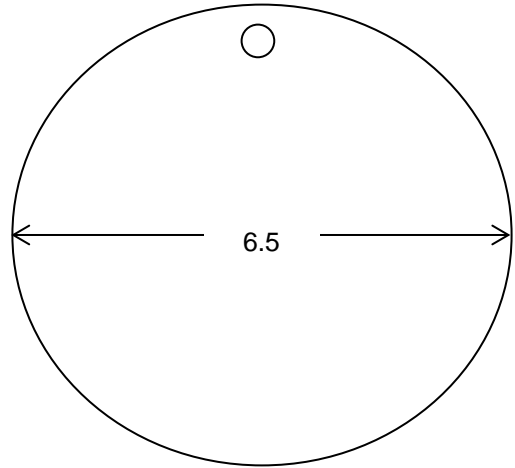
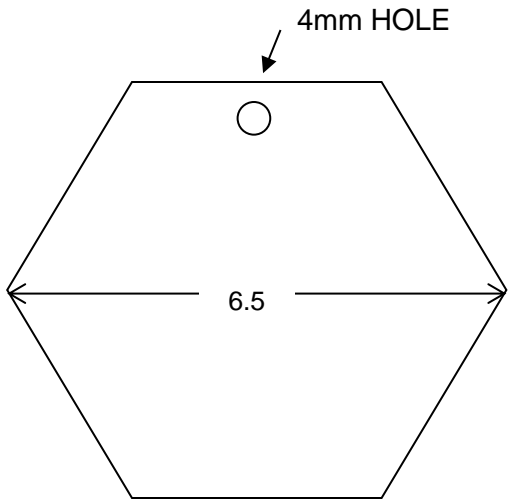

**APPENDIX IV
ADDITIONAL SPECIFICATIONS AND SHORT LIST OF KNOWN SUPPLIERS.
OTHER LOCAL SUPPLIERS MAY BE KNOWN.**

ALUMINUM TAGS & VINYL TAGS

White aluminum tags may have to be painted, not anodized.

Cowan Graphics Inc.
801A 47th Street East
Saskatoon, SK S7K 8G7

Tel: (306) 652-9988
Fax: (306) 652-9962
Website: www.cowan.ca
E-mail: Saskatoon@cowan.ca

Macfarlane Nameplate & Anodizing Corp.
185 Carlingview Dr., Unit 7
Toronto ON M9W 5E8

Toll Free Phone: (800) 267-6263
Fax:(416) 675-8915
Website:www.macnameplate.com
E-mail: sales@macnameplate.com

Alpine Graphic Productions Ltd.
34 Magnum Dr.
Schomberg, ON L0G 1T0

Toll Free Phone: (800) 265-8699
Fax: (905) 939-2668
Website: www.alpinegraphics.ca
E-mail: info@alpinegraphics.ca

Groupe Jaly
1036, route Fossambault
Saint-Augustin-de-Desmaures, QC
G3A 1W8

Toll Free Phone: (800) 529-5259
Fax: (418) 878-6262
Website : www.groupenjico.com
E-mail : info@groupejaly.ca

VINYL TAGS

Southwest Business Products Ltd.
20 Dovedale Court
Toronto ON M1S 5A7

Tel: (416) 285-7044
Fax: (416) 285-6721
Toll Free: (877) 285-7044
E-mail: sales@southwestbusiness.ca
Website: www.southwestbusiness.ca

Cowan Graphics Inc.
#55, 4511 Glenmore Trail SE
Calgary AB T2C 2R9

Tel: (403) 233-9200
Fax: (866) 372-9078
E-mail: calgary@cowan.ca
Website: www.cowan.ca

FILL BOX INSERTS

The suggested fillbox insert is TXP Extruded Polyester 40 point (1/32") available from Transilwrap of Canada Ltd. and Southwest Business Products Ltd. cut into 33" x 6" strips.

The appropriate generic name is screened to the back of this poly, readable from the front, in two offset rows, top and bottom, in a colour contrasting the color code of the product which is screened to cover the balance of the back of the strip. The clear face protects the colour code and lettering. The strip may be cut in half, lengthwise, to provide 2 - 33" x 3" inserts.

DECALS

Made to the minimum company standard for decal material with applicable colour and generic name.

APPENDIX V HISTORY OF CHANGES TO THE CODE

- **January 1990** First Edition (revised Dec. 2008/Nov. 2009/May 2012)
- **September 1993** (revised April 2007/Jan. 2009) - added Ethanol Blended Gasoline and Low Sulphur Diesel
- **January 1995** (revised April 2007/Jan. 2009) - added Dyed Ethanol Blended Gasoline and Dyed Low Sulphur Diesel
- **January 2007** - added a diamond shape tag category for Chemicals (2.1.2) and added the product Denatured Ethanol
- **January 2009** - added Ethanol 85 (Clear and Dyed) to the hexagonal tag category for Gasoline (Section 2.1.2). Typically referred to as E85.
- **May 2012** - updated the definition for biodiesel
- **November 2022**
 - Removed Jet B, Avgas 80, Jet A1, A2 and A5 from Section 1.2.5 and removed the corresponding tags in Appendix 1
 - Added octane ratings for gasoline in Section 2.2
 - Created tags for super premium ethanol and super premium ethanol dyed in Appendix 1
 - Consolidated all addendums into the body of the Code